

# COTEK

## SK120,SK200,SK350 Series Pure Sine Wave Inverter User's Manual



## Table of contents

- 1. Important Safety Information.....**
  - 1-1 General Safety Precautions.....
  - 1-2 Precautions When Working with Batteries.....
- 2. Features.....**
  - 2-1 Electrical Performance.....
  - 2-2 Mechanical Drawing of Socket Type(Power Claw PP75)... ..
  - 2-3 Mechanical Drawing of Strip Wire Type.....
- 3. Instructions.....**
  - 3-1 Front Panel Operation.....
  - 3-2 Rear Panel Operation.....
  - 3-3 Protections Features.....
  - 3-4 Installation.....
  - 3-5 Making DC Wiring Connections.....
  - 3-6 AC Safety Grounding.....
  - 3-7 Inverter Operation.....
- 4. Troubleshooting guide.....**
- 5. Maintenance.....**
- 6. Warranty.....**



## 1. Important Safety Information



### **WARNING!**

Before installing and using the Inverter, you need to read the following safety information carefully.

### **1-1. General Safety Precautions**

- 1-1-1. Do not expose the Inverter to rain, snow, spray, bilge or dust. To reduce risk of hazard, do not cover or obstruct the ventilation openings. Do not install the Inverter in a zero-clearance compartment. Over heating may result.
- 1-1-2. To avoid a risk of fire and electronic shock. Make sure that existing wiring is in good electrical condition; and that wire size is not undersized.  
Do not operate the Inverter with damaged or substandard Wiring.
- 1-1-3. This equipment contains components which can produce arcs or sparks. To prevent fire or explosion do not install in compartments containing batteries or Flammable materials or in locations which require ignition protected equipment. This includes any space containing gasoline-powered machinery, fuel tanks, or joints, fittings, or other connection between components of the fuel system.

### **1-2. Precautions When Working with Batteries**

- 1-2-1. If battery acid contacts skin or clothing, wash immediately with soap and water. If acid enters eye, immediately flood eye with running cold water for at least 20 minutes and get medical attention immediately.
- 1-2-2. Never smoke or allow a spark or flame in vicinity of battery or engine.
- 1-2-3. Do not drop a metal tool on the battery. The resulting spark or short-circuit on the battery or other electrical part may cause an explosion.
- 1-2-4. Remove personal metal items such as rings, bracelets, necklaces, and watches when working with a lead-acid battery, A lead-acid battery produces a short-circuit current high enough to weld a ring or the like to metal, causing a severe burn.



## 2. Features

- Pure sine wave output (THD < 3%)
- Output frequency : 50 / 60Hz switch selections
- Input & output completely isolated design
- High efficiency 84~94%
- Capable of driving inductive & capacitive loads at the start moment.
- A LED Indicator with twin color displays all operation status.
- Loading and temperature controlled cooling fan.
- Built in advanced microprocessor to make friendly interface with user.
- Protection : Input low voltage                  Overload                  Short circuit  
                                Low battery alarm                  Input over voltage                  Over temperature



## 2-1. Electrical Performance

Specification	Model No.					
Item	SK120-112	SK120-124	SK120-148	SK120-212	SK120-224	SK120-248
Continuous Output Power	120W					
Maximum Output Power	132W					
Surge Rating (Max)	240W					
Input voltage	12Vdc	24Vdc	48Vdc	12Vdc	24Vdc	48Vdc
Output Voltage	100 / 110 / 120Vac +/- 5%			220 / 230 / 240Vac +/- 3%		
Frequency (Switch Selections)	50 / 60Hz +/- 0.05%					
Output Waveform	Pure Sine Wave ( THD < 3% )					
Efficiency (full load) Max <sup>*1</sup>	89%	91%	93%	92%	93%	94%
Input Voltage Regulation	10.5-15 VDC	21.0-30 VDC	42-60 VDC	10.5-15 VDC	21.0-30 VDC	42-60 VDC
Failure Indicator	Red LED					
Protection	Overload (Shut down), Short Circuit (Shut down), Reverse Polarity (Fuse), Over / Under Input Voltage (Auto recovery), Over Temperature (Auto recovery).					
Remote Control	Yes (ON / OFF mode controlled by hard wire) See 3-2					
Safety	Meet UL458		EN60950-1			
EMC	FCC Class A		EN55022:1997 EN61000-3-2:1998 EN61000-3-3:1995 EN55024:2001		e-mark e13 023495	
Operating Temperature Range	0 - 40 °C					
Storage Temperature Range	-30°C to 70°C					
Cooling	convection cooling					
Dimensions	185(L)x147(W)x60(H)mm / 7.3(L)x5.8(W)x2.36(H) Inch					
Weight	1kg					

Note: The specifications are subject to change without notice.

\*1 : This test condition is normal DC input (13.5V) and temperature 25°C.

Specification	Model No.					
Item	SK200-112	SK200-124	SK200-148	SK200-212	SK200-224	SK200-248
<b>Continuous Output Power</b>	200W					
<b>Maximum Output Power</b>	220W					
<b>Surge Rating (Max)</b>	400W					
<b>Input voltage</b>	12Vdc	24Vdc	48Vdc	12Vdc	24Vdc	48Vdc
<b>Output Voltage</b>	100 / 110 / 120Vac +/- 5%			220 / 230 / 240Vac +/- 3%		
<b>Frequency (Switch Selections)</b>	50 / 60Hz +/- 0.05%					
<b>Output Waveform</b>	Pure Sine Wave ( THD < 3% )					
<b>Efficiency (full load) Max *1</b>	87%	90%	92%	90%	93%	94%
<b>Input Voltage Regulation</b>	10.5-15 VDC	21.0-30 VDC	42-60 VDC	10.5-15 VDC	21.0-30 VDC	42-60 VDC
<b>Failure Indicator</b>	Red LED					
<b>Protection</b>	Overload (Shut down), Short Circuit (Shut down), Reverse Polarity (Fuse), Over / Under Input Voltage (Auto recovery), Over Temperature (Auto recovery).					
<b>Remote Control</b>	Yes (ON / OFF mode controlled by hard wire) See 3-2					
<b>Safety</b>	Meet UL458		EN60950-1			
<b>EMC</b>	FCC Class A		EN55022:1997 EN61000-3-2:1998 EN61000-3-3:1995 EN55024:2001		e-mark e13 023496	
<b>Operating Temperature Range</b>	0 - 40 °C					
<b>Storage Temperature Range</b>	-30°C to 70°C					
<b>Cooling</b>	FAN (Controlled by load and temperature)					
<b>Dimensions</b>	185 (L) x 147 (W) x 60 (H) mm / 7.3 (L) x 5.8 (W) x 2.36 (H) Inch					
<b>Weight</b>	1.2kg					

Note: The specifications are subject to change without notice.

\*1 : This test condition is normal DC input (13.5V) and temperature 25°C.

Specification	Model No.					
Item	SK350-112	SK350-124	SK350-148	SK350-212	SK350-224	SK350-248
Continuous Output Power	350W					
Maximum Output Power	385W					
Surge Rating (Max)	700W					
Input voltage	12Vdc	24Vdc	48Vdc	12Vdc	24Vdc	48Vdc
Output Voltage	100 / 110 / 120Vac +/- 5%			220 / 230 / 240Vac +/- 3%		
Frequency (Switch Selections)	50 / 60Hz +/- 0.05%					
Output Waveform	Pure Sine Wave ( THD < 3% )					
Efficiency (full load) Max *1	84%	86%	88%	86%	89%	90%
Input Voltage Regulation	10.5-15 VDC	21.0-30 VDC	42-60 VDC	10.5-15 VDC	21.0-30 VDC	42-60 VDC
Failure Indicator	Red LED					
Protection	Overload (Shut down), Short Circuit (Shut down), Reverse Polarity (Fuse), Over / Under Input Voltage (Auto recovery), Over Temperature (Auto recovery).					
Remote Control	Yes (ON / OFF mode controlled by hard wire) See 3-2					
Safety	Meet UL458		EN60950-1			
EMC	FCC Class A		EN55022:1997 EN61000-3-2:1998 EN61000-3-3:1995 EN55024:2001		e-mark e13 023497	
Operating Temperature Range	0 - 40 °C					
Storage Temperature Range	-30°C to 70°C					
Cooling	FAN (Controlled by load and temperature)					
Dimensions	185(L)x147(W)x60(H)mm / 7.3(L)x5.8(W)x2.36(H) Inch					
Weight	1.4kg					

Note: The specifications are subject to change without notice.

\*1 : This test condition is normal DC input (13.5V) and temperature 25°C.

## 2-2. Mechanical Drawing of Socket (Power Claw PP75)

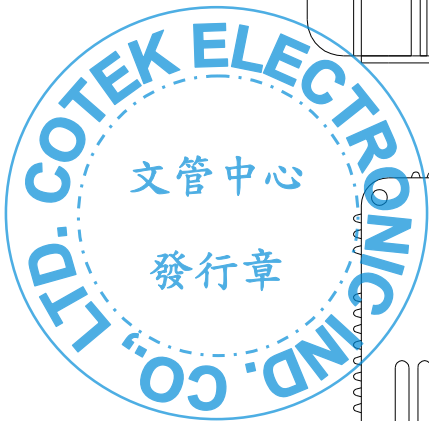
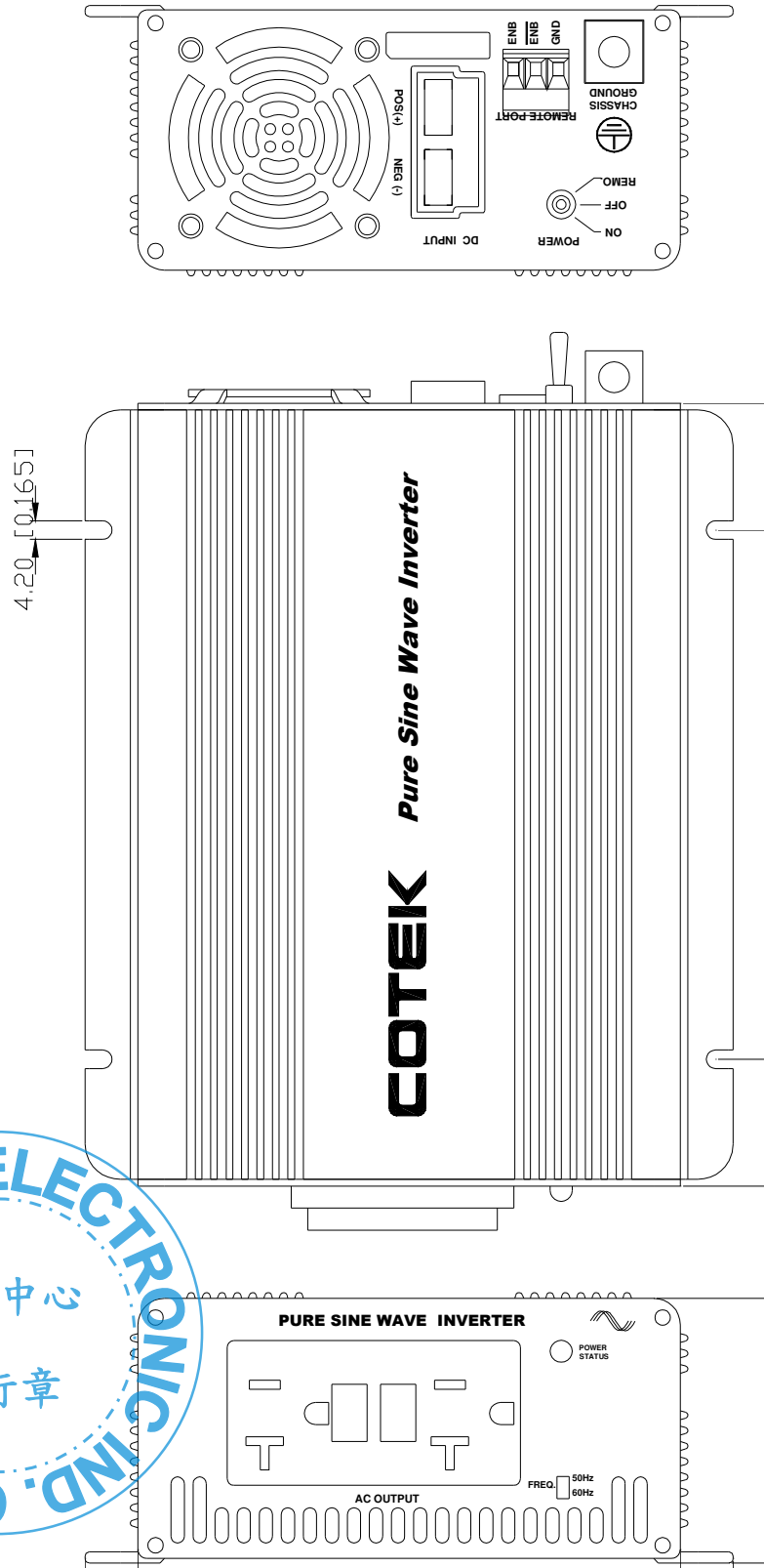

## 2-3. Mechanical Drawing of Strip Wire Type

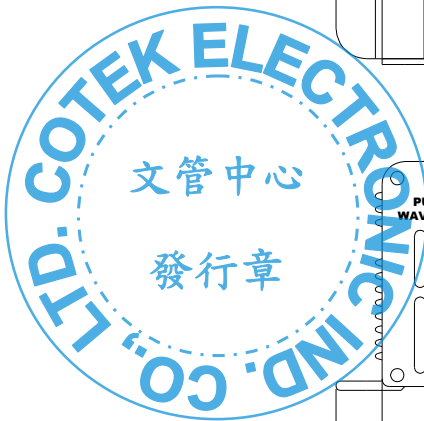
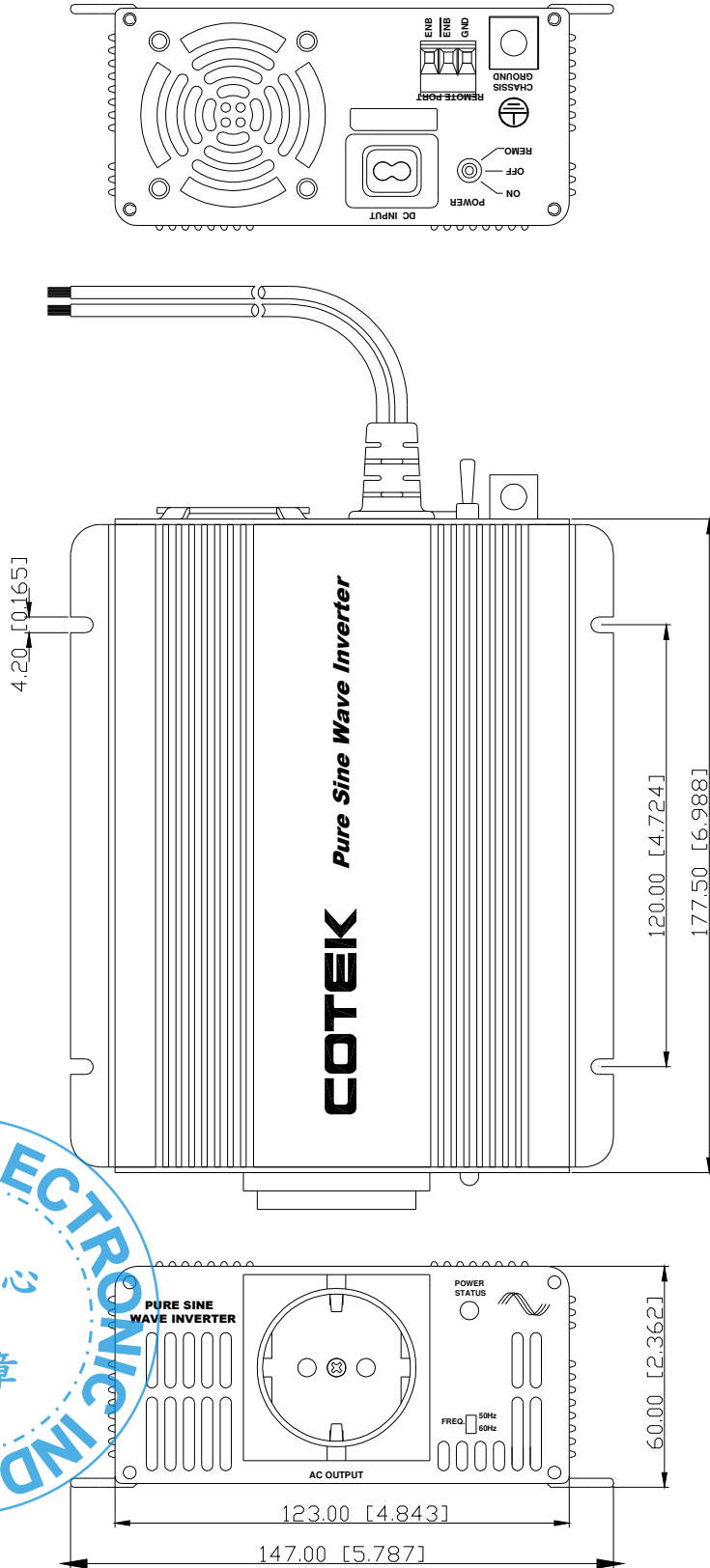

## 3. Instructions

This power inverter series is a the member of the most advanced line of mobile AC power systems available.

To get the most out of the power inverter, it must be installed and used properly. Please read the instructions in this manual before installation and operation this model.

### 3-1. Front Panel Operation :

#### 3-1-1. Front view :

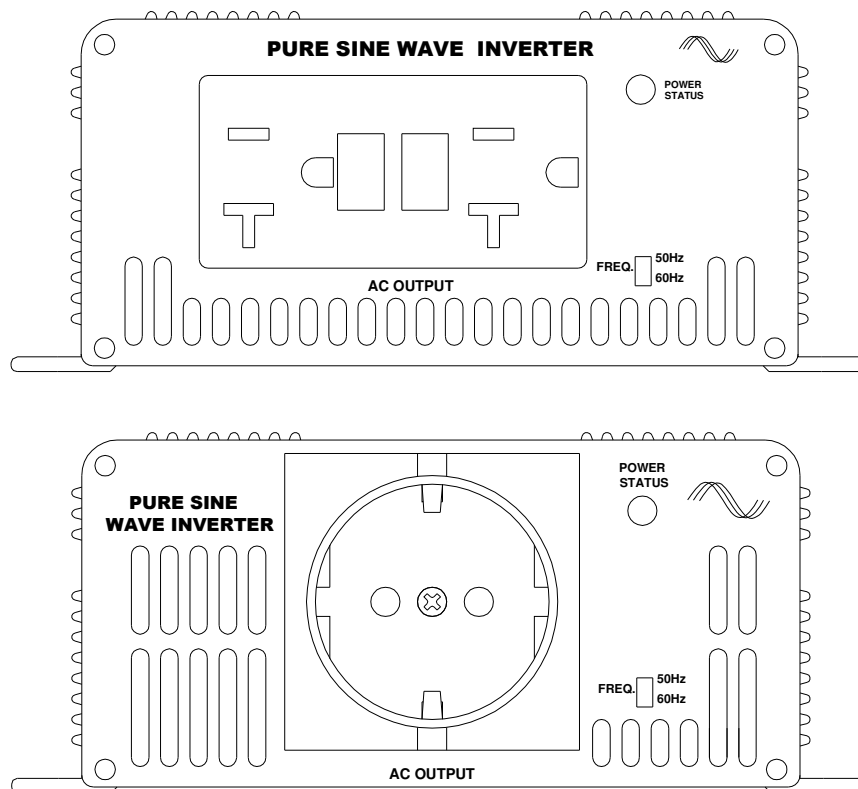

#### 3-1-2. AC Frequency : Selected by Dip Switch

Frequency	Dip Switch
50 HZ	ON
60 HZ	OFF

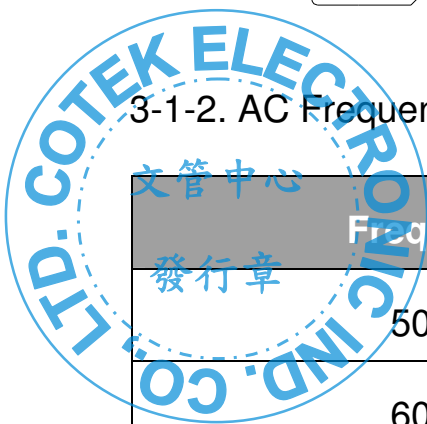

### 3-1-3. Status : Display Power & Fault Status

Green LED	LED Signal	Status
Solid	—————	Power OK
Red LED	LED Signal	Status
Blink (Fast)	- - - - -	OVP
Blink (Slow)	- - - -	UVP
Blink (Intermittently)	.. ..	OTP
Solid	—————	OLP

### 3-1-4. AC Output (available Sockets) :

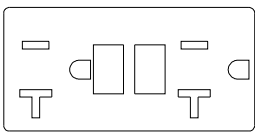
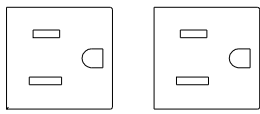
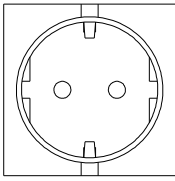
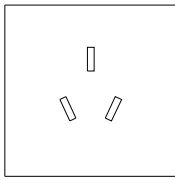
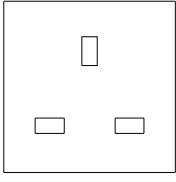
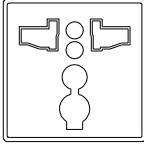
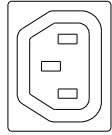
			
<b>North America (GFCI)</b>	<b>NEMA 5-15R</b>	<b>Continental Europe</b>	<b>Australia / New Zealand</b>
			
<b>United Kingdom</b>	<b>Universal</b>	<b>IEC</b>	

### 3-1-5. DC Input (available type) :

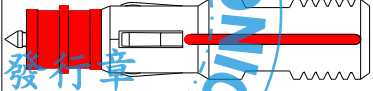
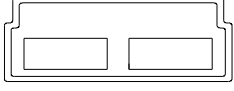
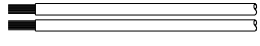
<b>CIGARET</b> 	<b>PP75</b> 	<b>STRIPPED WIRE</b> 
---	--	---

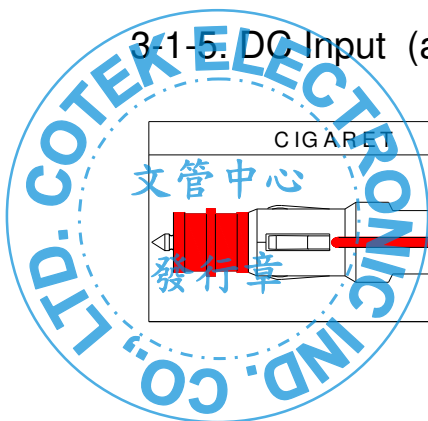

## 3-2. Rear Panel Operation :

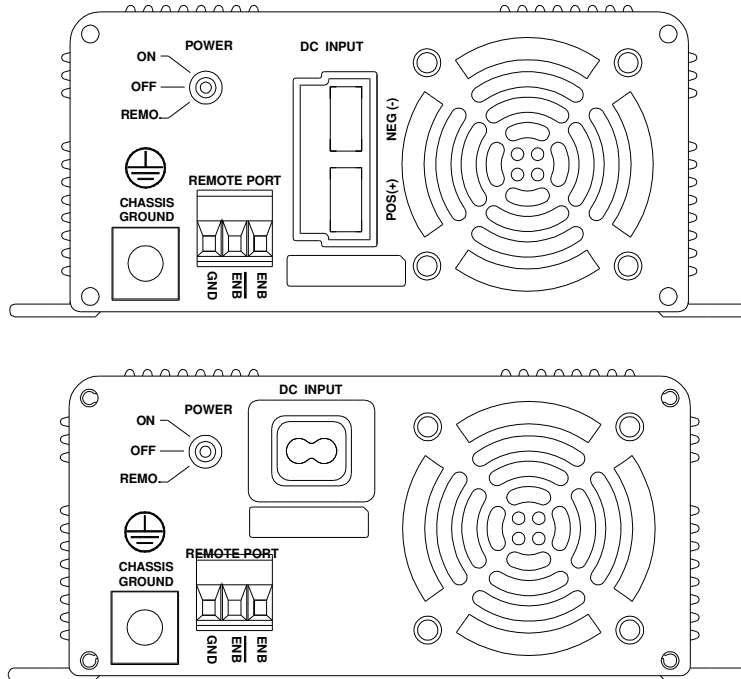

### 3-2-1. ON / OFF / REMOTE Main Switch.

- 3-2-1-1. Before installing the inverter, make sure the main switch must be "OFF".
- 3-2-1-2. Before using the remote unit, make sure the main switch must be "REMOTE".
- 3-2-1-3. Ensure the remote control contact is off.
- 3-2-1-4. Remote Port : Place 0.75mm<sup>2</sup> and Screw type cable between the remote port and the panel.
- 3-2-1-5. Remote port ON/OFF inverter setup status

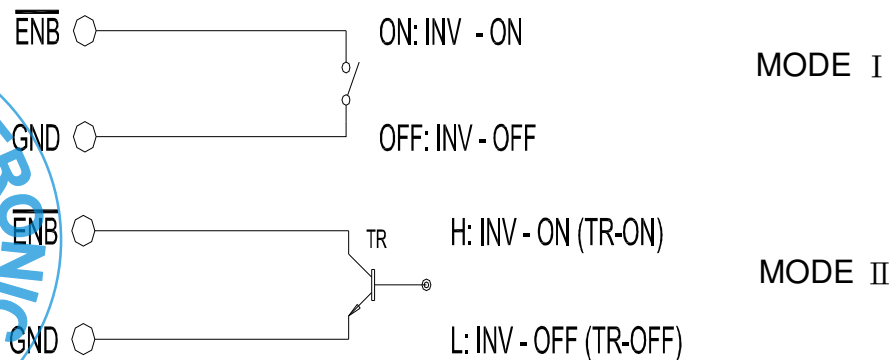

VCEO > VBAT

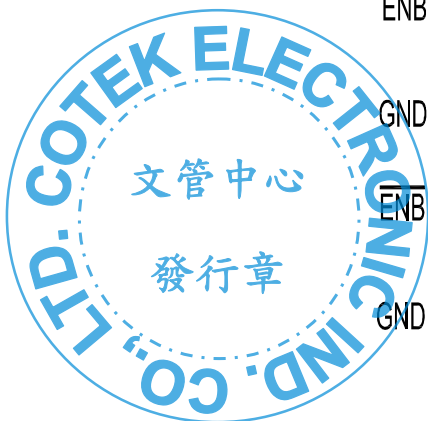

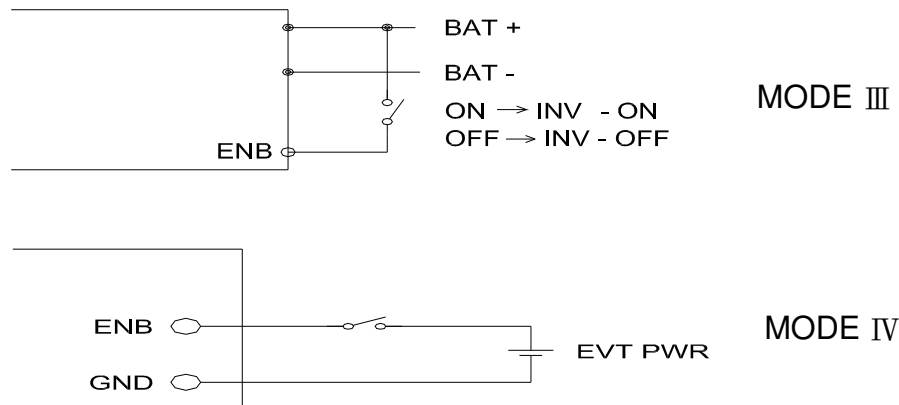

**NOTE: Only one of control mode can be presented. When operating.**

### 3-2-2. DC Input Terminals :

Connect to 12V / 24V / 48V battery or the other power sources. **【+】** is positive, **【-】** is negative. Reverse polarity connection will blow internal fuse and may damage inverter permanently.

Model	DC Input Voltage	
	Minimum	Maximum
12 V	10.5	15.0
24 V	21.0	30.0
48 V	42.0	60.0

### 3-2-3. Chassis Ground: using # 8 AWG wire to connect vehicle chassis.

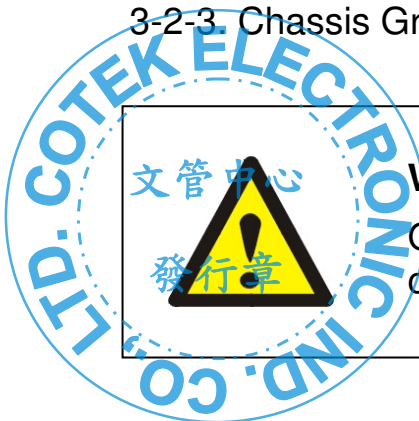

#### **WARNING!**

Operation of the inverter without a proper ground connection may result in an electrical safety hazard.

### 3-3. Protections Features:

Model	DC Input (VDC)					Over Temperature Protection	
	Over Voltage		Under Voltage Alarm	Under Voltage		INTERIOR	
	Shut-down	Restart		Shut-down	Restart	Shut-down	Restart
12 V	16V	13V	11.0V	<10.5V	12.5	55°C	45°C
24 V	32V	26V	22.0V	<21.0V	25.0		
48V	62V	52V	44.0V	<42.0V	50.0		

Note: The specifications are subject to change without notice.

### 3-4. Installation :

Where to install. The power inverter should be installed in a location that Meets the following requirements :

3-4-1. Dry – Do not allow water to drip or splash on the inverter.

3-4-2. Cool – Ambient air temperature should be between 0°C and 40°C, the cooler the better.

3-4-3. Safe – Do not install in a battery compartment or other areas where flammable fumes may exist, such as fuel storage areas or engine compartments.

3-4-4. Ventilated – Allow at least one inch of clearance around the inverter for air flow. Ensure the ventilation openings on the rear and front of the unit are not obstructed.

3-4-5. Dust – Do not install the Inverter in a dusty environments where are dust, wood particles or other filings/shavings are present. These dust can be pulled into the unit when the cooling fan is operating.



- 3-4-6. Close to batteries – Avoid excessive cable lengths but do not install the Inverter in the same compartment as batteries.  
Use the recommended wire lengths and sizes (see section 3-5).  
Also do not mount the Inverter where it will be exposed to the gases produced by the battery.  
These gases are very corrosive and prolonged exposure also will damage the Inverter.



### **WARNING!**

Shock Hazard. Before proceeding further, carefully check that the Inverter is NOT connected to any batteries, and that all wiring is disconnected from any electrical sources. Do not connect the output terminals of the Inverter to an incoming AC source.

### **3-5. Making DC Wiring Connections :**

Follow this procedure to connect the battery cables to the DC input terminals of the Inverter. Your cables should be as short as possible (Ideally, less than 6 feet / 1.8 meters ) enough to handle the required current in accordance with the electrical codes or regulations application. Cables are not an adequate gauge (too narrow) or too long will decrease the inverter performances such as poor surge capability and low input voltage warnings frequently and shutdowns. UVP warning presents due to DC voltage drop across the cables from the inverter to the batteries.

The longer or narrower the cables, the greater the voltage drop.

Increasing your DC cable size will help improve the situation.

Following cable recommendations for the best performance of inverter.

(Apply both 120V and 230V versions )



### **WARNING!**

The installation of a fuse must be on positive cable. Failure to place a fuse on “+” cables running between the inverter and battery may cause damage to the inverter and will void warranty.

## 3-6. AC Safety Grounding :

The AC output ground wire should go to the grounding point for your loads ( for example, a distribution panel ground bus ).

### 3-6-1. Neutral Grounding (GFCI'S) :

3-6-1-1. **120V models** : The neutral conductor of the AC output circuit of the Inverter is automatically connected to the safety ground during inverter operation. In accordance with the National Electrical Code requirements that separately derived AC sources (such as inverter and generators) have their neutral conductors tied to ground in the same way that the neutral conductor from the utility is tied to ground at the AC breaker panel. For models configured with a transfer relay, while AC utility power is presenting and the Inverter is in bypass mode, this connection (neutral of the Inverter's AC output to input safety ground) is not present so that the utility neutral is only connected to ground at your breaker panel, as required.

3-6-1-2. **230V models** : There is no connection made inverter interior between either the line or neutral conductor to the safety ground.



### **WARNING!**

Risk of electronic shock. Use only Pass and Seymour, type 2095-W or 7899-W, ground – fault circuit-interrupter receptacles. Others may fail in operating the inverter when connecting to the inverter's equipment.

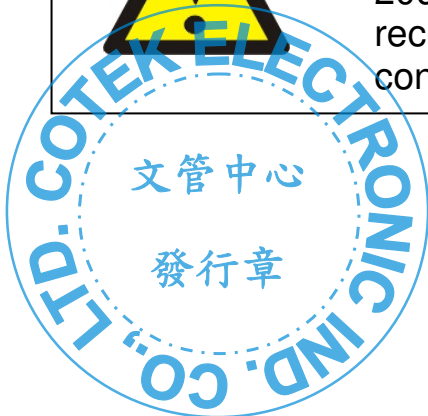

## Ground Fault Circuit Interrupters (GFCI) :

Installations in Recreational Vehicles (for North American approvals) will require GFCI protection of all branch circuit connected to the AC output of the hardwire terminal equipped Inverter. In addition, electrical codes require GFCI protection of certain receptacles in residential installations. While the pure sine wave output of the Inverter is equivalent to the waveform provided by utilities, compliance with UL standards requires us to test and recommend specific GFCI. Cotek has tested the following GFCI – protected 20A receptacles and found that they functioned properly when connected to the output of the Inverter.

## 3-7. Inverter Operation :

To operate the power inverter, turn the main switch ON. The power inverter is now ready to deliver AC power to your loads. If there is several loads use, turn them on separately after the inverter has been “ON” in order to prevent the OVP present caused by the surge power.

3-7-1. Set the power switch to the “ON” position and the buzzer will send out “Beep” sounds at the moment the inverter will do self-diagnosis, then the Power Status LED indicators will also appear various colors. Finally the buzzer will sound another “Beep” and the Power Status LED indicators will turn to “Green” color, the inverter starts working successfully.

3-7-2. Set the power switch to the OFF position, the inverter stops and all the lights that are On, go Off.

3-7-3. Set power inverter switch to the ON position and turn the test load On. The inverter should supply power to the load. If you plan to accurately measure the true output r.m.s. voltage of inverter, a meter such as FLUKE 45 BECKMAN 4410 or TRIPLETT 4200 must be used.

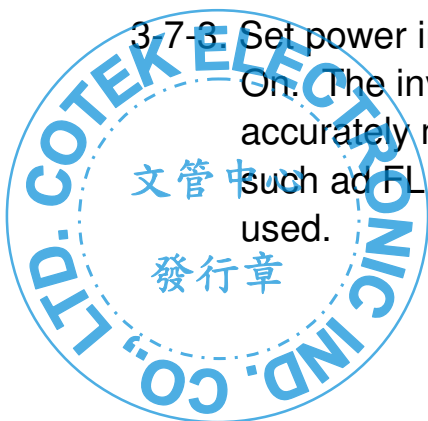

## 4. Troubleshooting guide :



### WARNING!

Do not open or disassemble the Inverter.  
Attempting to service the unit yourself may result in a risk of electrical shock or fire.

Problems and Symptoms	Possible Cause	Solutions
"No AC Power Output"		
<b>STATUS illuminates the red LED</b>		
a. Blinking fast	Over input voltage. ( OVP )	Check input voltage. Reduce input voltage.
b. Blinking slow.	Low input voltage. ( UVP )	Recharge battery. Check connections and cable.
c. Blinking Intermittently.	Thermal shutdown. ( OTP )	Improve ventilation. Make sure ventilation openings in inverter are not obstructed. Reduce ambient temperature.
d. Solid ON	Short circuit or Wiring error. Overload.(OLP)	Check AC wiring for short circuit. Reduce load.



## 5. Maintenance :

Very little maintenance is required to keep your inverter operating properly. You should clean the exterior of the unit periodically with a damp cloth to prevent accumulation of dust and dirt.

At the same time, tighten the screws on the DC input terminals.

## 6. Warranty :

We warrant this product against defects in materials and workmanship for a period of 24 months from the date of purchase and will repair or replace any defective Power Inverter when directly returned, postage paid, to us.

This warranty will be considered void if the unit has suffered any obvious physical damage or alteration either internally or externally and does not cover damage arising from improper use such as plugging.

The unit into an unsuitable power sources attempts to operate products with excessive power consumption requirements, or use in unsuitable environments.

This is the only warranty that the company makes.

No other warranties express or imply including warranties of merchantability and fitness for a particular purpose.

Repair and replacement are your sole remedies and the company shall not be liable for damages, whether direct, incidental, special or consequential, even though caused by negligence or other fault.

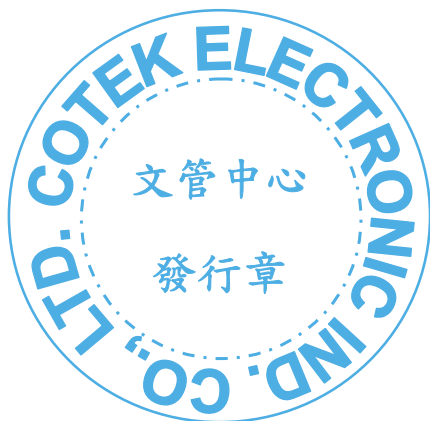



**COTEK**

No. 33, Rong Hsin Rd., Pa Teh City, Tao Yuan County, Taiwan

Phone : 886-3-3661581 FAX : 886-3-3676029

E-mail : [sales@cotek.com.tw](mailto:sales@cotek.com.tw) http : // [www.cotek.com.tw](http://www.cotek.com.tw)